

Decoder mit Digitalstrom versorgen

Digital-current supply to the decoder

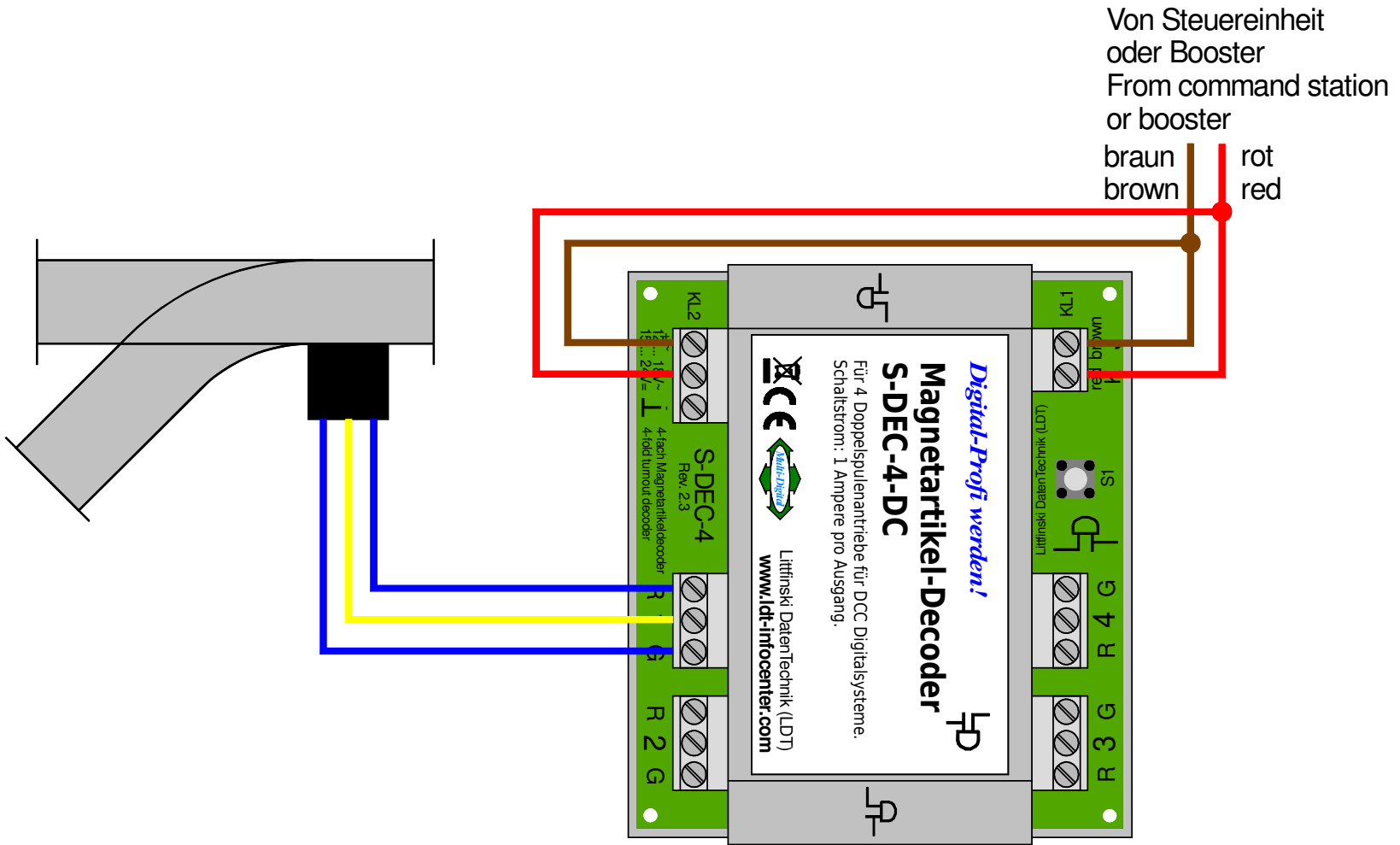

Technische Änderungen und Irrtum vorbehalten.
Subject to technical changes and errors.
© 02/2020 by LDT