

TT-DEC-R Rückmeldung: Position erreicht und Bühnengleis belegt mit RM-GB-8-N (2-Leiter Gleis)

TT-DEC-R Feedback report: Position received and turntable bridge track occupied by RM-GB-8-N (2-rail conductor)

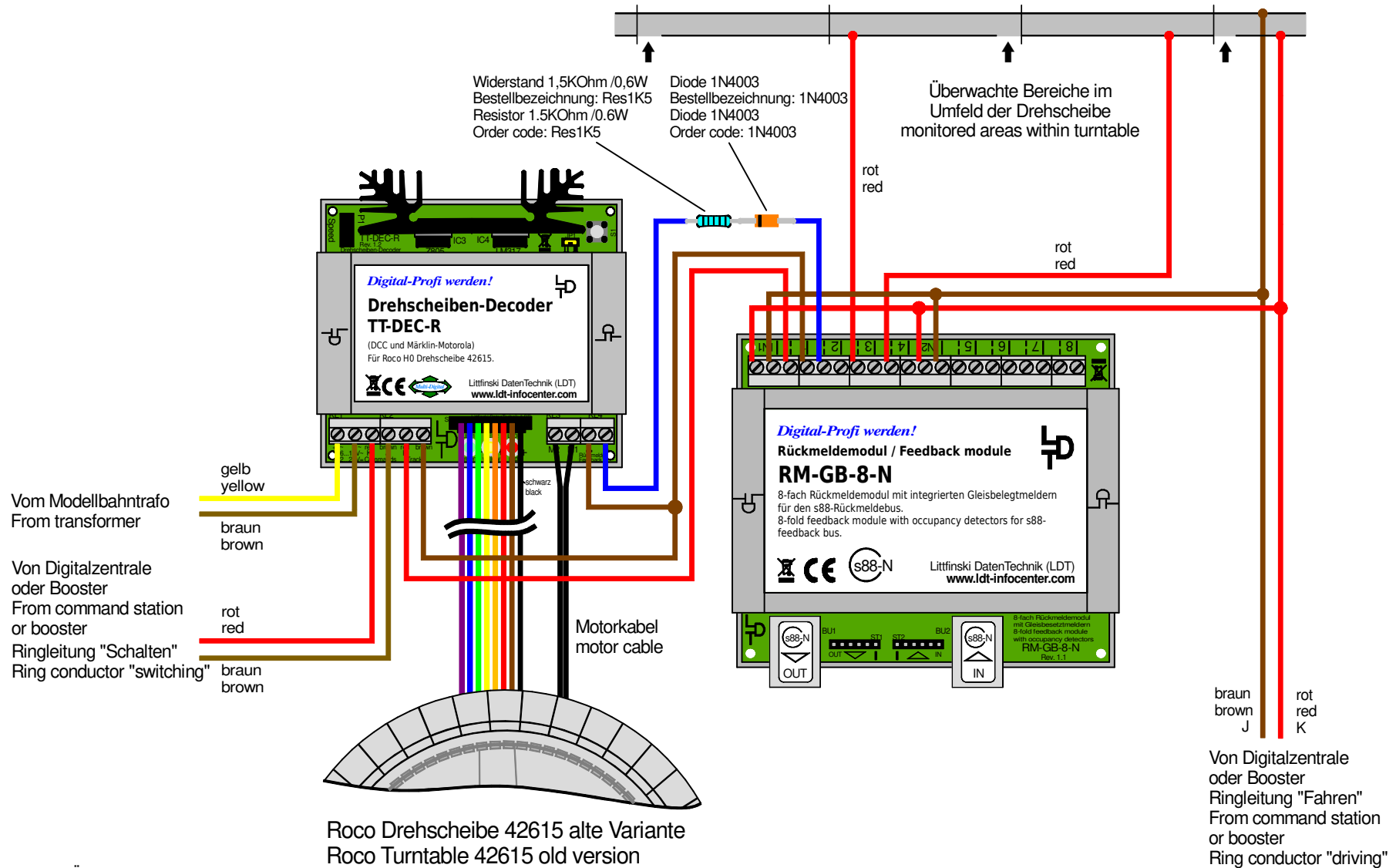

Technische Änderungen und Irrtum vorbehalten.
Subject to technical changes and errors.
© 02/2020 by LDT

