

Datenweiche DSW-88-N an ECoS 2 (50200) (verschiedene Rückmeldemodule)

Data switch DSW-88-N on ECoS 2 (50200) (various feedback modules)

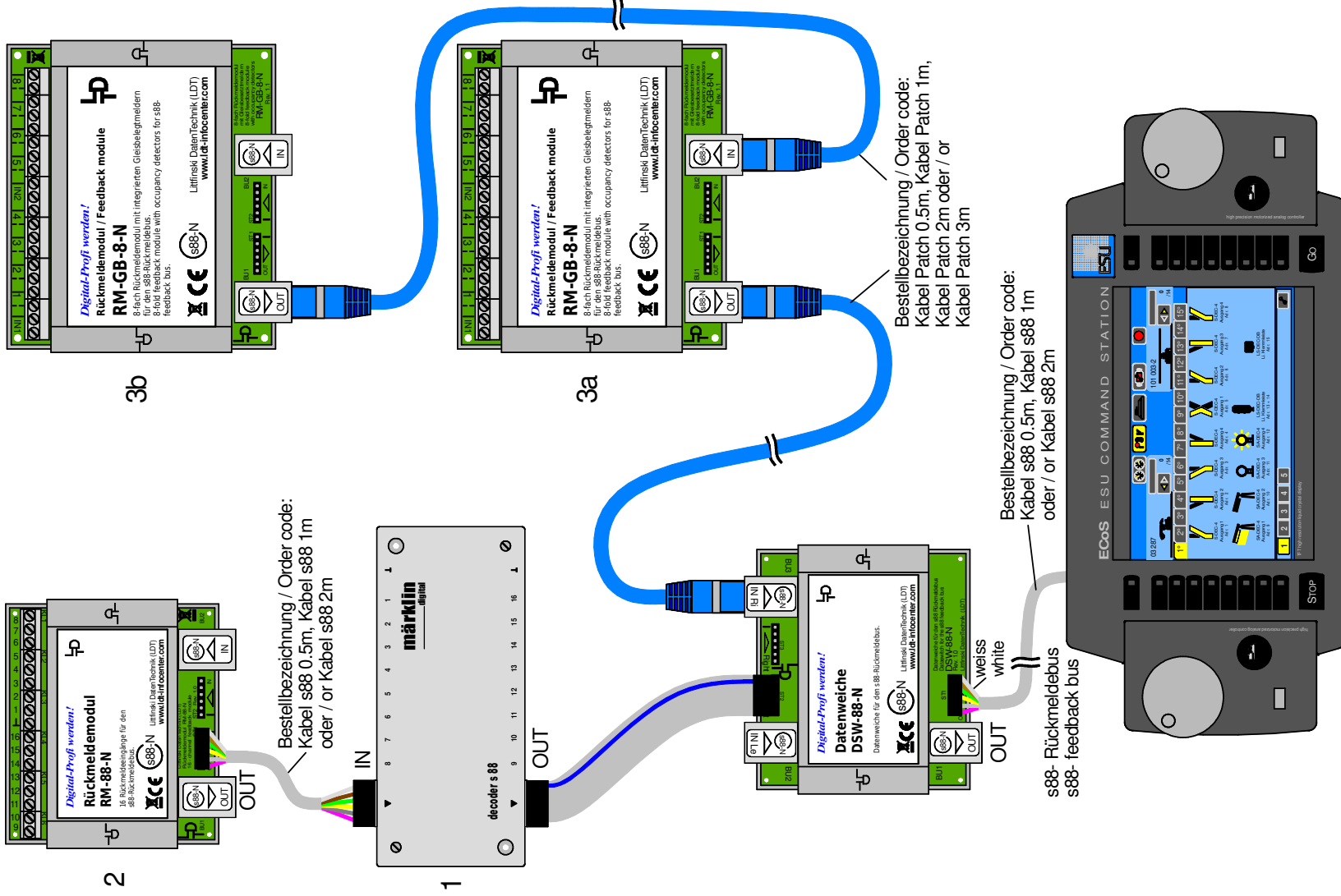

Technische Änderungen und Irrtum vorbehalten.
Subject to technical changes and errors.

© 05/2020 by LDT