

Datenweiche DSW-88-N an der Intellibox II (verschiedene Rückmeldemodule)

Data switch DSW-88-N on Intellibox II (various feedback modules)

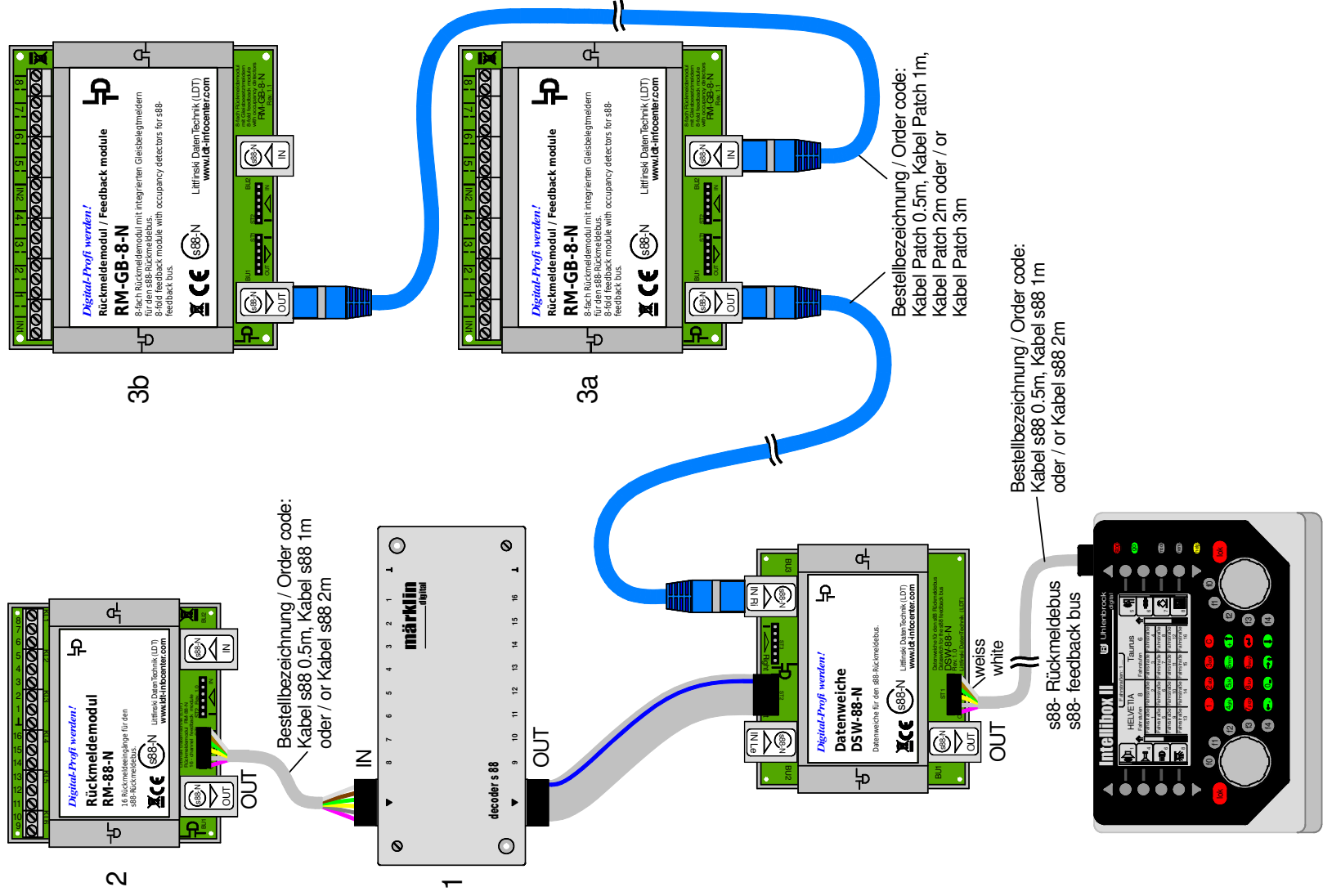

Technische Änderungen und Irrtum vorbehalten.
Subject to technical changes and errors.

© 05/2020 by LDT

