

Externe Stop/Go-Taster anschließen (Gleichspannungsversorgung)

Connecting external Stop/Go push-buttons (DC voltage supply)

Fahren und Schalten
driving and switching

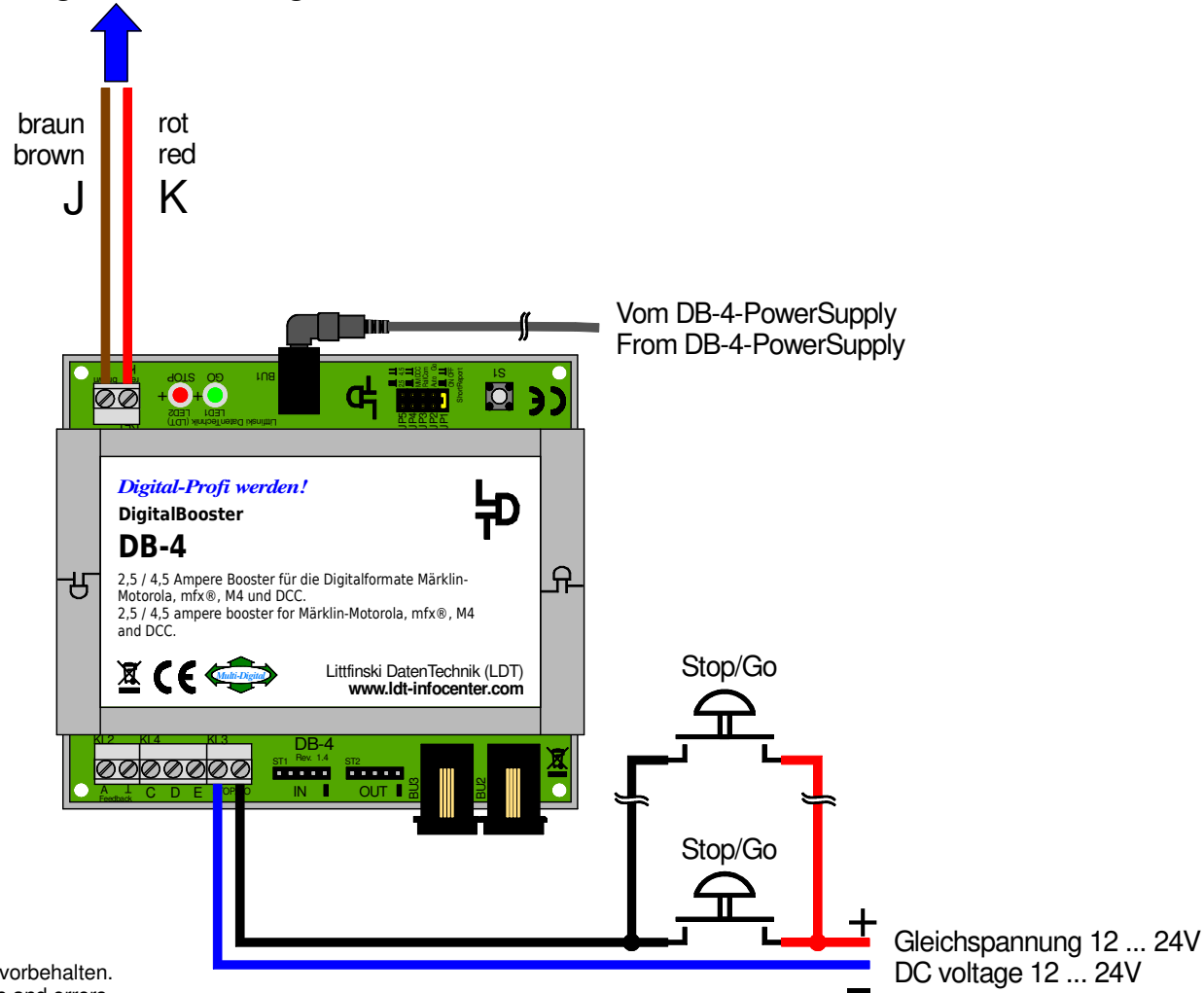

Technische Änderungen und Irrtum vorbehalten.
Subject to technical changes and errors.
© 06/2020 by LDT

