

Extra Digitalstromleitung für die Decoder

Separate digital-current conductor for the decoder

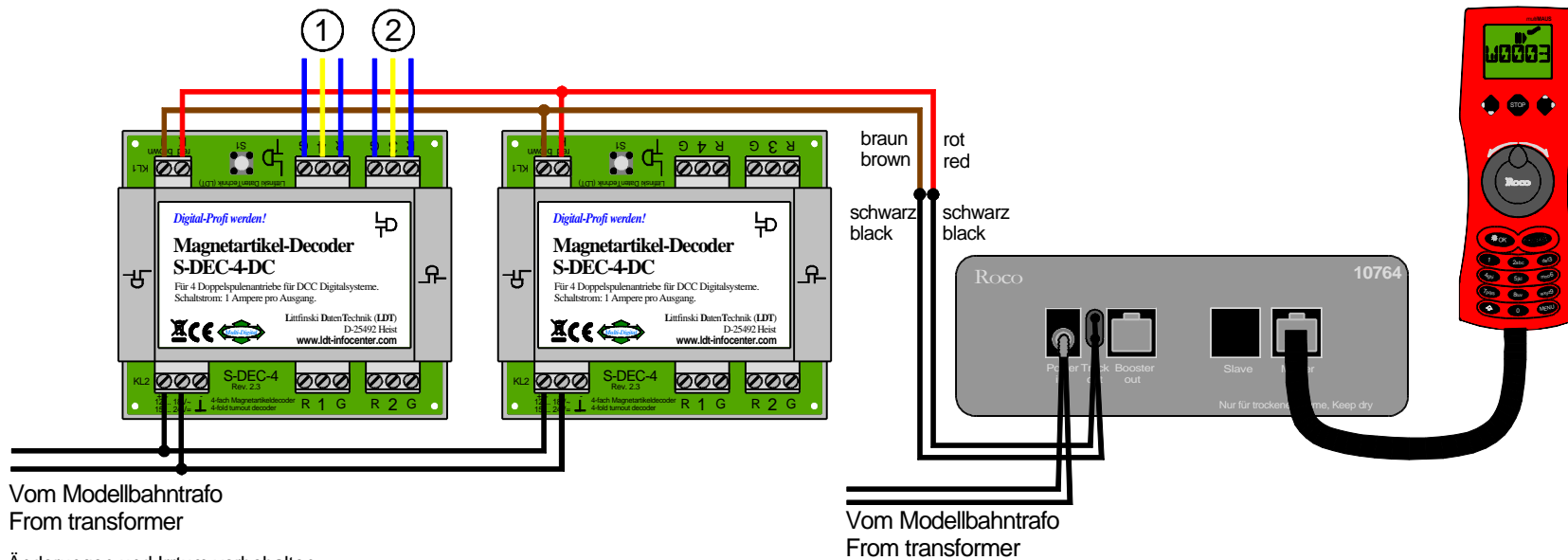

Technische Änderungen und Irrtum vorbehalten.
Subject to technical changes and errors.
© 01/2016 by LDT

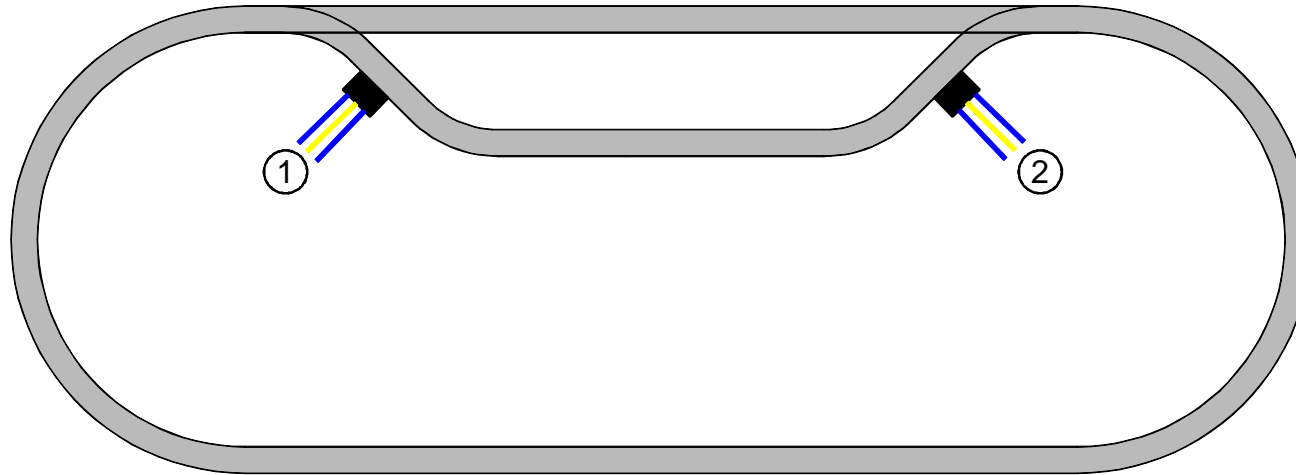