

Gleisbelegtmeldung in der Kehrschleife (mit KSM1 von MÜT)

Occupancy detection at a reversing loop (with KSM1 from MÜT)

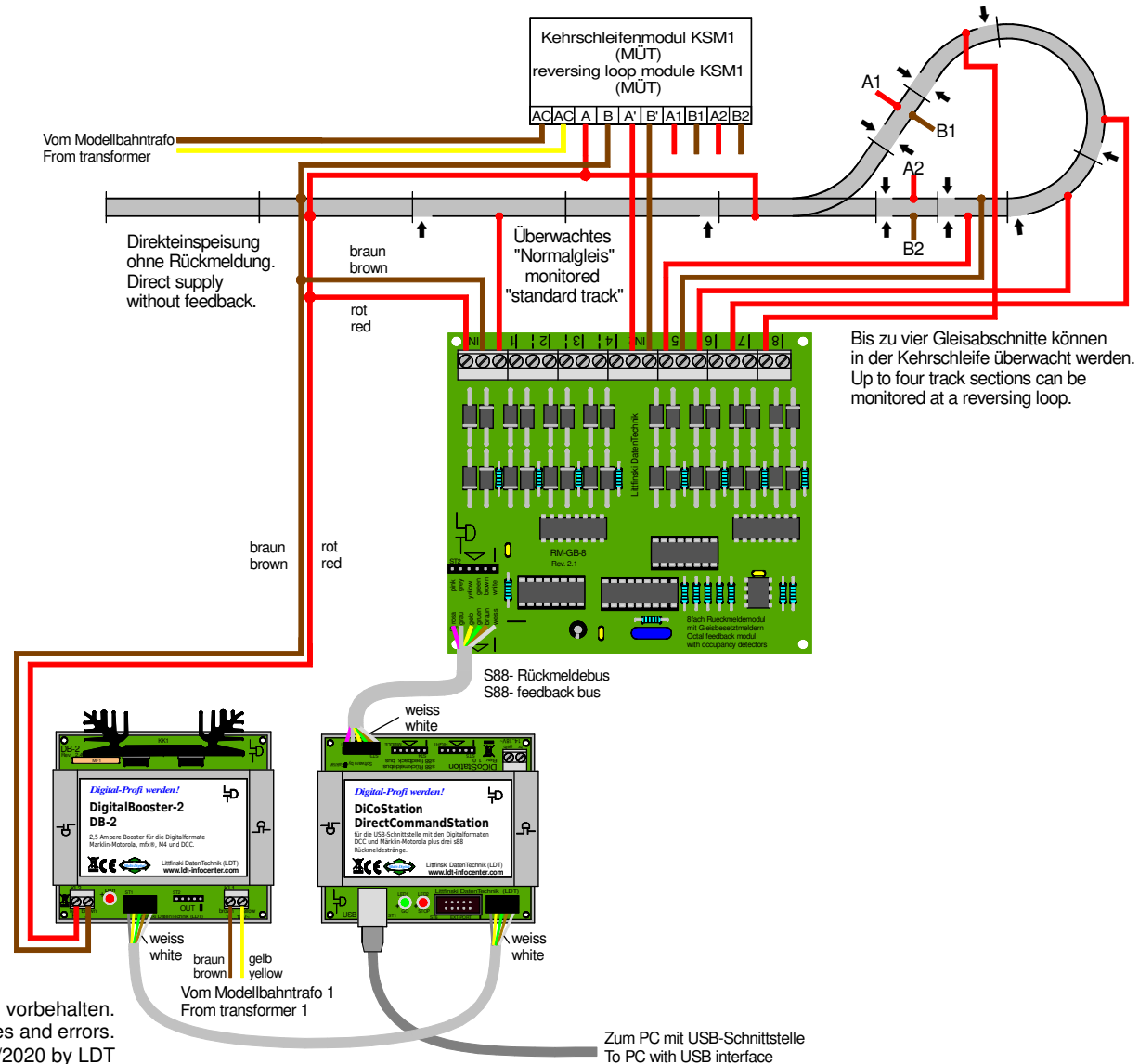

Technische Änderungen und Irrtum vorbehalten.
Subject to technical changes and errors.
© 10/2020 by LDT