

Pilz / Tillig-Antrieb (86110) mit Weichenrückmeldung (s88-Rückmeldebus)

Pilz / Tillig-Drive (86110) with turnout feedback (s88-feedback bus)

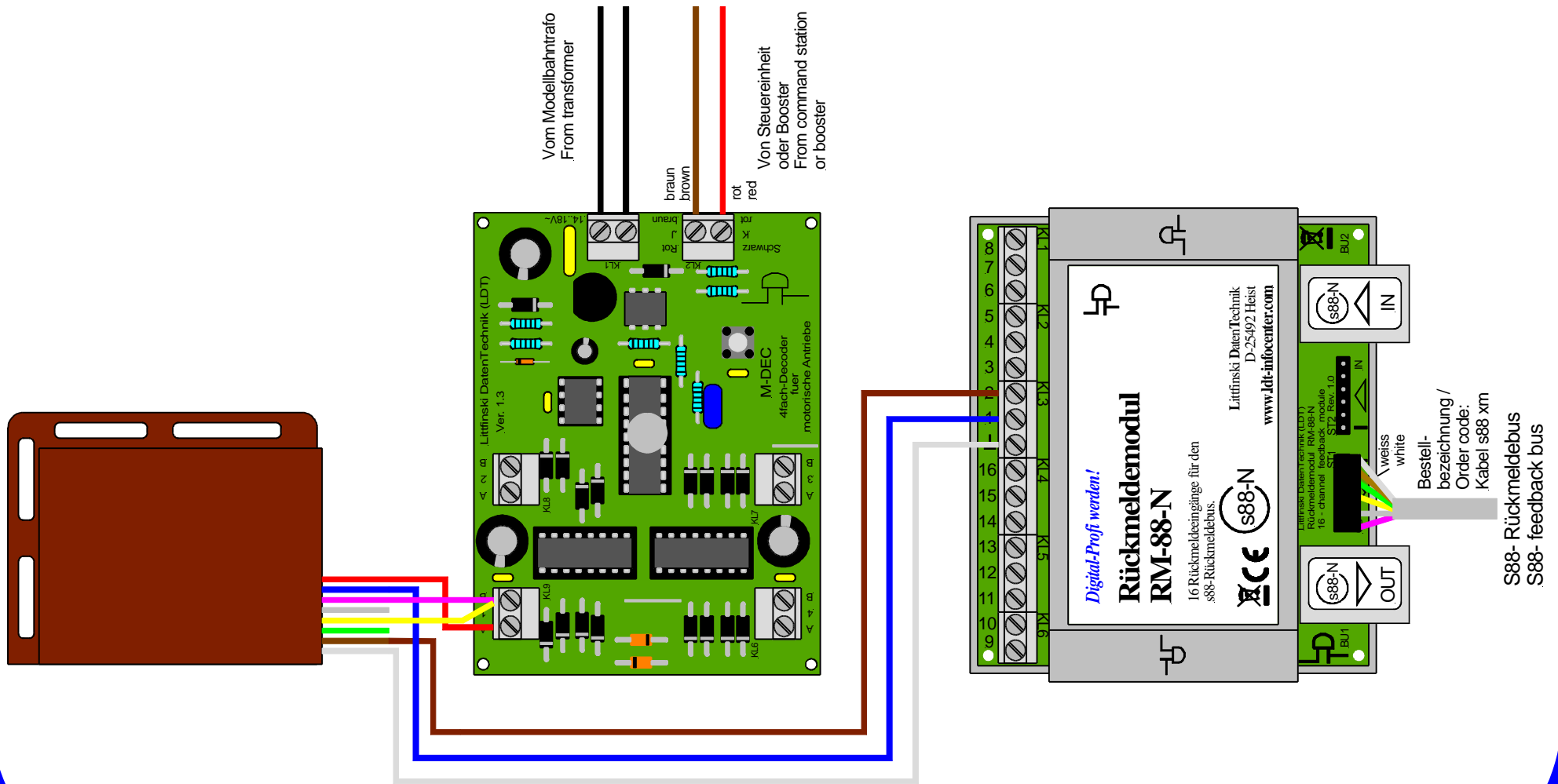

Technische Änderungen und Irrtum vorbehalten.
Subject to technical changes and errors.
© 01/2012 by LDT