



Light-Signal Decoder

for light-signals with LED

from the *Digital-Professional-Series* !

LS-DEC-USA-F Part-No.: **510612**

>> finished module <<

Suitable for the digital systems:
Märklin-Motorola and **DCC**

For direct digital control of:

- ⇒ four American Color Light Signals.
- ⇒ for LED-light signals with common anode or common cathode.

Realistic operation of the signal aspects by implemented **dimming function** and **dark phase** between the switching of the signal aspects.

This product is not a toy! Not suitable for children under 14 years of age!
The kit contains small parts, which should be kept away from children under 3!
Improper use will imply danger of injuring due to sharp edges and tips! Please store this instruction carefully.



Label:
USA



Introduction/Safety instruction:

You have purchased the Light-Signal Decoder **LS-DEC-USA** for your model railway as a kit or as finished module.

We are wishing you having a good time using this product.

The Light-Signal Decoder **LS-DEC** of the *Digital-Professional-Series* can be easily operated on your digital model railway.

By using a **connector plug bridge** you can **select** if you want to connect the decoder to a **Märklin-Motorola** system or to a digital system with **DCC** standard.

The finished module comes with **24 month warranty**.

- Please read the following instructions carefully. Warranty will expire due to damages caused by disregarding the operating instructions. **LDT** will also not be liable for any consequential damages caused by improper use or installation.
- Also, note that electronic semiconductors are very sensitive to electrostatic discharges and can be destroyed by them. Therefore, discharge yourself before touching the modules on a grounded metal surface (e.g. heater, water pipe or protective earth connection) or work on a grounded electrostatic protection mat or with a wrist strap for electrostatic protection.
- We designed our devices for indoor use only.

Connecting the decoder to your digital model railway layout:

- **Attention:** Before starting the installation-work switch off the layout voltage supply (switch-off the transformers or disconnect the main supply).

The Light-Signal Decoder **LS-DEC** is suitable for the **DCC data format** as used e.g. by **Lenz-Digital Plus**, **Roco-Digital** (switching via **Keyboard** or **multiMAUS** only; switching via **Lokmaus 2®** and **R3®** is not possible), **Zimo**, **LGB-Digital**, **Intellibox**, **TWIN-CENTER**, **DiCoStation**, **ECoS**, **EasyControl**, **KeyCom-DC** and **Arnold-Digital** / **Märklin-Digital=** whenever **no** connector plug bridge is inserted in position **J2**.

The decoder is suitable for **Märklin-Digital~ / Märklin Systems** or **Märklin-Motorola** layout (e.g. **Control-Unit**, **Central Station**, **Intellibox**, **DiCoStation**, **ECoS**, **EasyControl**, **KeyCom-MM**) if you insert a connector plug bridge on **J2**.

The decoder receives the **digital information** via the clamp **KL2**. Connect the clamp with a rail or even better connect the clamp to an own digital main ring supply assuring the supply of digital information free from any interference.

Please attend to the marking on clamp **KL2**. The colors '**red**' and '**brown**' next to the clamp are usually used by **Märklin-Motorola** systems (e.g. **Märklin-Digital~ / Märklin Systems / Intellibox DiCoStation / EasyControl**).

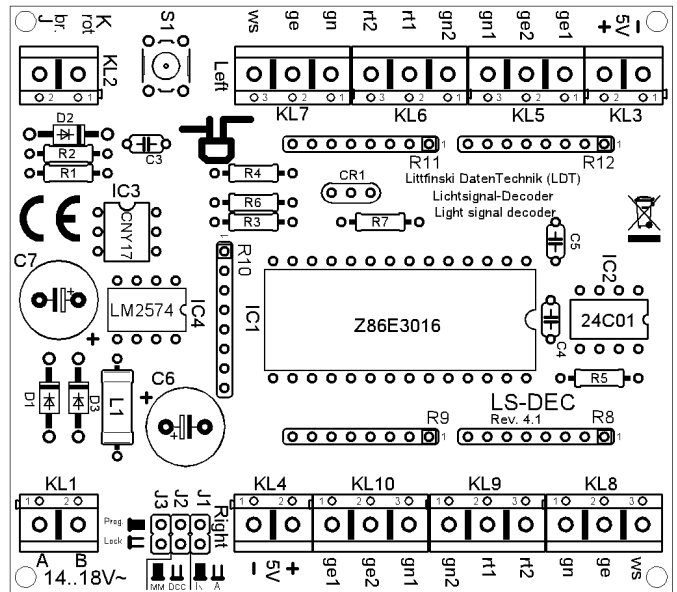

Lenz-Digital systems are using the letters '**J**' and '**K**'.

In case you assemble the decoder to an **Arnold-Digital (old)-** or **Märklin-Digital=** system, you have to connect '**black**' to '**K**' and '**red**' to '**J**'.

The decoder receives the **power supply** via the two poles clamp **KL1**. The voltage shall be in a range of 14...18V~ (alternate voltage output of a model rail road transformer).

If you do not want to supply voltage **separately from a transformer** to the **LS-DEC decoder** you can **shorten** the clamp **KL1** and **KL2** with two wires. In this case the decoder will get the power supply **completely** from the **digital network**.

Connecting the signals:

General:

Up to **4 signals** can be connected to the **Light-Signal Decoder LS-DEC**. **Two signals per each 11poles clamp block**. The build-up of the two clamps is identical. The following description refers mainly to one clamp only. As you can see on the identical marking the description is also valid for the second clamp.

Common connection:

All LED-signals of any manufacturer are designed in accordance to the same principle. One wire of all light emitting diodes of a signal will be generally connected to a common cable. Depending if all anodes or all cathodes are connected together the signals will be called as **common anodes-** respectively **common cathodes-signal**.

If you use signals with **common anodes** (e.g. supplied from Viessmann or alphamodell) you have to clamp the cable to the connection marked '+'. In addition you shall **not insert** the **connection plug bridge** in **J1** in this case.

If you use signals with **common cathodes** you have to clamp this cable to the connection marked '-'. In addition you shall **insert** the **connection plug bridge** in **J1** in this case.

The second connection of each light diode is separated and mostly color marked at the end and contains a series resistor.

Series resistor:

Light diodes have **always** to be operated with a suitable **series resistor** to prevent that they will be destroyed. For this prevention **all outputs** have already a **series resistor of 330 Ohm** integrated on the printed circuit board of the **Light-Signal Decoder LS-DEC**. Is there no further external resistor the diode-current will be about 10 mA.

This provides **sufficient brightness**.

For assigning the **single cables of the light diodes** to the **correct clamp connection** please attend to the below **signal images**. The **marks** next to **signal light diodes** are not corresponding to the actual light color but to the marking of the **connection at the Light-Signal Decoder LS-DEC**.

If you do not know the correct allocation of the single wires to the light emitting diodes you can **test** the function by connecting the wires to **clamp RT1**. This output is **active** because the decoder switches **all signals to red after switching on**.

1. Connection of two 3-aspect signals:

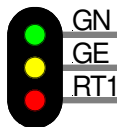

2. Connection of two 2-aspect signals:

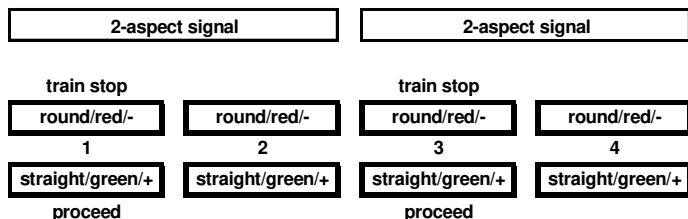
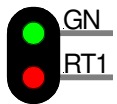

3. Connection of one 2- and one 3-aspect signal:

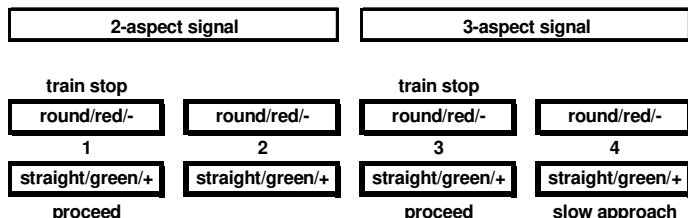
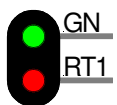

Colored Operation Instructions and Sample Connections can be found at the Internet on our Web-Site (www.ldt-infocenter.com) within the section "Downloads" and "Sample Connection". Additionally you can find detailed information about the Light-Signal Decoder LS-DEC-USA at our Web site within the section "Digital-Compendium".

Programming the decoder address:

- The jumper J3 has to be inserted for the programming of the decoder addresses.
- Switch on the power supply of your model rail way layout.
- Activate the programming key S1.
- At least two light emitting diodes on a signal connected to the left clamp block (on this decoder side is the programming key S1) will be automatically switched-over every 1.5 seconds in a flashing mode. This indicates that the decoder is in the programming mode.
- Press now one key of the fourfold address-group to be assigned to the left clamp block of the decoder. For programming the decoder address you can also release a turnout switch signal via a personal computer.

Remarks: The decoder addresses for magnet accessories also to be used for the signal-aspects are combined into groups of four. The address 1 to 4 build the first group. The address 5 to 8 build the second group etc. Each clamp block of a LS-DEC decoder can be assigned to any of these groups. It does not matter which of the eight possible keys used for programming will be activated. The decoder stores always the complete group of keys.

- If the decoder has recognized the assignment correctly the connected light emitting diode will flash a little faster. Afterwards the flashing slows down to the initial 1.5 seconds again. In case the decoder will not recognize the address it could be that the two digital information connections (clamp2) are wrong connected. For testing this, switch off the power supply, exchange the connection on KL2 and start addressing again.
- Press now the programming key S1 again. At least two light emitting diodes connected to the right clamp block will flash now. Repeat the programming as described above.
- Now press the programming key S1 a third time for leaving the programming mode. All signals will be automatically switched to STOP.

Signal switching:

The opposite sample connections show how the fourfold address-group can be set by use of 8 keys of the push button panel for setting the turnouts or signals. Between each pair of keys are e.g. the addresses 1 to 4. The two keys red and green for each address are assigned to the turnout position round or straight respectively the corresponding signal aspect which is indicated above or below key. The actual address section is related to which fourfold address-group has been selected during the programming. If you use a remote control LH100 of Company Lenz Elektronik then red will be the minus key and green the plus key.

If you have connected two 3-aspect signals two one of the two clamp bars as shown at the first sample you can switch the left signal to "proceed" with the address 1 and the key green. The light emitting diode marked with GN will now indicate this at the signal.

With the address 3 and the key green you can switch the right signal to proceed. The light emitting diode marked with GN1 will now indicate this at the signal.

Accessory:

For easy assembly of the printed circuit board below your model rail road base plate we offer a set of assembly material under the order identification: MON-SET. Under LDT-01 you can purchase a low price durable suitable case for the LS-DEC.

Attention:

The Light-Signal Decoder LS-DEC switches the signal aspect not just on and off but is dimming the light emitting diodes realistic up and down. Even between the signal aspects a short off-phase is provided. Further digital commands received during this switch-over-time of about 0.4 seconds will not be taken up from the decoder. Please take care that the switching-commands are not in a too fast sequence. The impression is absolutely realistic if the switching is considerable slow. If the jumper J3 will be removed after programming of the decoder addresses the memory storage of the Light-Signal Decoder LS-DEC will be protected against any alteration.

Further products from the Digital-Professional-Series:

S-DEC-4

4-fold Turnout Decoder for four magnet article with free programmable decoder address and external power supply possibility.

RM-GB-8-N / RS-8

8-fold Feedback Module with integrated track occupancy detectors for the s88- respectively RS-feedback bus.

All components are available as easy to assemble complete kits, as simple to assemble finished modules or as finished modules in a case.

Made in Europe by
Littfinski DatenTechnik (LDT)
Bühler electronic GmbH
Ulmenstraße 43
15370 Fredersdorf / Germany
Phone: +49 (0) 33439 / 867-0
Internet: www.ldt-infocenter.com

Subject to technical changes and errors. © 09/2022 by LDT
Märklin and Motorola are registered trade marks.